

# HORIZON 125x50

**CATALANO**  
THE ESSENCE OF CERAMICS

Installazione sospesa, mobile o su struttura.  
*It can be installed wall-hung, structure or sit-on installation on a dedicated cabinet*  
*Installation suspendue, sur structure ou sur meuble.*

- cod. 1125HZ00 Bianco lucido | Glossy white
- cod. 1125HZBM Bianco satinato | Satin white
- cod. 1125HZCS Cemento satinato | Satin cement
- cod. 1125HZNS Nero satinato | Satin black



CE EN 14688 - CL00

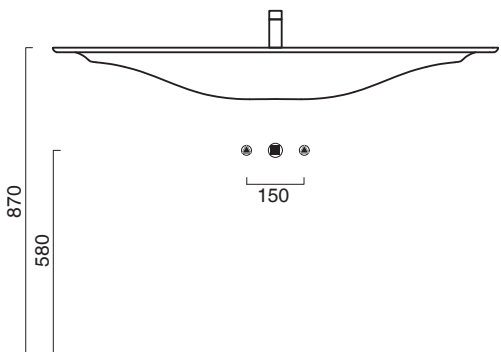
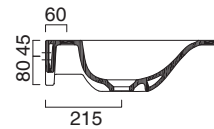
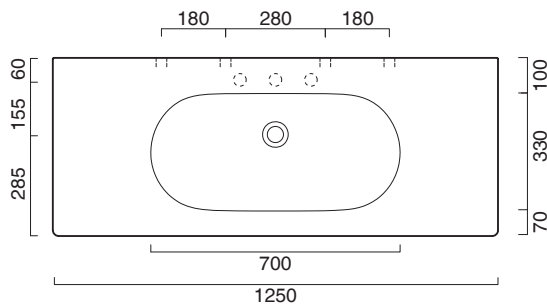

Tutti i diritti sulla presente scheda appartengono a Ceramica Catalano S.p.A. in via esclusiva. È vietata la copia, la pubblicazione, la distribuzione o la riproduzione (anche parziale), se non autorizzata per iscritto.  
All rights in the present form belong exclusively to Ceramica Catalano S.p.A. It is strictly forbidden to copy, publish, distribute or reproduce it (including any partial reproduction), without prior written permission.

Portasciugamani in alluminio.  
Aluminium towel rail.  
Porte serviette en aluminium.

- cod. 5P125HZ00 Cromo | Chrome
- cod. 5P125HZNS Nero satinato | Satin black

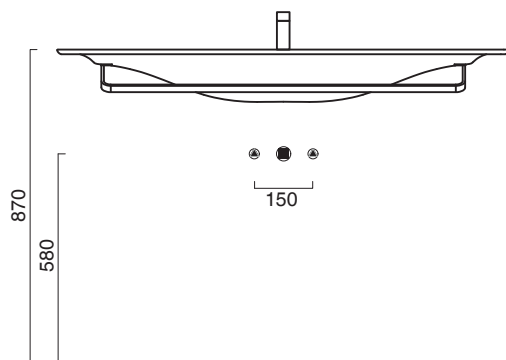

Struttura in alluminio completa di ripiano in laminato.  
Wall-mounted aluminum frame with laminate shelf.  
Structure en aluminium avec plan en stratifié.

- cod. 5S1255000 Inox scotch-brite
- cod. 5S12550BM Bianco satinato | Satin white
- cod. 5S12550NS Nero satinato | Satin black

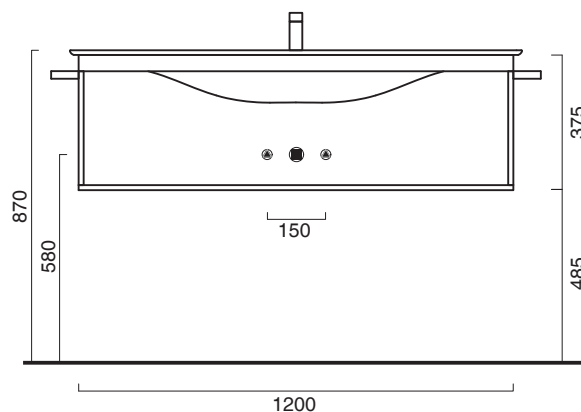

Mobile con struttura in alluminio anodizzato, rivestimento in MDF CARB (#) laccato con vernici all'acqua, cassetto con guide ad estrazione totale, chiusura ammortizzata ed apertura tip-on.  
Furniture with anodized aluminum unit, MDF CARB (#) coating lacquered with water-based paints, full extension drawer slides, tip-on opening and soft closing drawer.  
Meuble avec structure en aluminium anodisé, revêtement en MDF CARB (#) laqué avec des peintures à l'eau, tiroir avec glissières à sortie totale, fermeture amortie et ouverture tip-on.

- cod. 5M12550BM Bianco satinato | Satin white
- cod. 5M12550CS Cemento satinato | Satin cement
- cod. 5M12550MS Marrone satinato | Satin brown

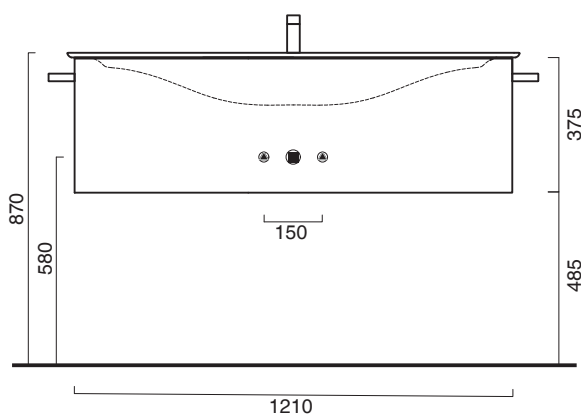

\* con sifone cod. 5SFSP00 - with siphon cod. 5SFSP00

(#) L'MDF CARB è un prodotto legnoso a bassa emissione di formaldeide  
(#) MDF CARB is an engineered wood product which has low formaldehyde emission  
(#) Le MDF CARB est un produit en bois à faible émission de formaldéhyde

MADE IN ITALY

## GARANZIA

Il rivenditore sostituirà i prodotti con difetti di fabbricazione entro due anni dalla consegna.

*Your retailer will replace products with faults of manufacturing within two years from delivery date.*

*Der Wiederverkäufer wird Produkte mit Fabrikationsfehlern innerhalb 2 Jahren seit Zustellung ersetzen.*

*Le vendeur remplacera les produits présentant des défauts de fabrication dans un délai de deux ans à compter de leur livraison.*

## PULIZIA

Si consiglia di pulire con acqua tiepida e detersivo non abrasivo.

*The maintenance has to be done with tepid water and not abrasive detergents.*

*Für die Reinigung empfiehlt sich lauwarmes Wasser und keine Scheuermittel zu verwenden.*

*Nous conseillons de nettoyer à l'eau tiède, avec un détergent non abrasif.*

---

## DICHIARAZIONE DI PERFORMANCE - DOP No 14688

Scarica il documento al seguente link a lato:

*Click the link on the side to download the document:*

*Klicken Sie auf den Link zum Herunterladen des Dokuments:*

*Téléchargez le document au lien ci-contre:*

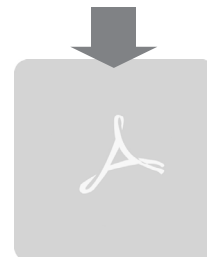

Antibacterial protection

**CATAglaze<sup>®</sup> + Silver Titanium**

**CATALANO**  
THE ESSENCE OF CERAMICS

MADE IN ITALY

L'INNOVATIVO SMALTO ANTIBATTERICO SU TUTTA LA CERAMICA  
THE INNOVATIVE ANTIBACTERIAL GLAZE IS STANDARD ON ALL  
CATALANO PRODUCTS.

L'ÉMAIL ANTIBACTÉRIEN NOVATEUR SUR TOUTE LA CÉRAMIQUE

**IT È un potenziamento dello smalto Cataglaze che, oltre a ridurre il deposito di calcare facilitando la pulizia dei sanitari ceramici, svolge una potente azione antimicrobica in grado di contrastare germi e batteri. L'efficacia della nuova formula è garantita dalla presenza nell'impasto di ioni d'argento e di titanio. L'azione antibatterica è certificata ISO 22196 con efficacia del 99,99%.**

**EN It is an improvement of Cataglaze glazing system; besides being more resistant to limescale and therefore easier to clean, it has a powerful antimicrobial action able to kill germs and bacteria. The effectiveness of the new formula is guaranteed by the presence in the mix of silver and titanium ions. The antibacterial action is ISO 22196 certified and it is 99.99% effective.**

**FR Il s'agit d'un renforcement de l'émail Cataglaze qui, en plus de réduire le dépôt de calcaire et donc faciliter le nettoyage des sanitaires en céramique, exerce une action antimicrobienne puissante en mesure de contraster les germes et les bactéries. L'efficacité de la nouvelle formule est garantie par la présence, dans le mélange, d'ions d'argent et de titane. L'action antibactérienne est certifiée ISO 22196 avec une efficacité de 99,99%.**



Silver Titanium  
Protezione antibatterica  
Silver Titanium  
Antibacterial protection  
Silver Titanium  
Protection antibactérienne

**99,99%**



Maggiore brillantezza  
Brightness  
Aspect brillant



Resistenza agli agenti chimici  
Resistance to chemicals  
Résistant aux agents chimiques



Rispetto per l'ambiente  
Respect for the environment  
Respect de l'environnement



Pulizia facile e rapida  
Quick cleaning  
Nettoyage rapide



Igiene totale  
Total hygiene  
Hygiène totale



Lunga durata di vita  
Long lifecycle  
Longue durée

Tutti i diritti sulla presente scheda appartengono a Ceramica Catalano S.p.A. in via esclusiva. È vietata la copia, la pubblicazione, la distribuzione o la riproduzione (anche parziale), se non autorizzata per iscritto. All rights in the present form belong exclusively to Ceramica Catalano S.p.A. It is strictly forbidden to copy, publish, distribute or reproduce it (including any partial reproduction), without prior written permission.